

**TRANSMISIÓN TRIANGULAR DE L= 1200mm, CRUCETA 35-106,5mm, TERMINALES 1 3/8"Z6  
HOMOCINÉTICA**

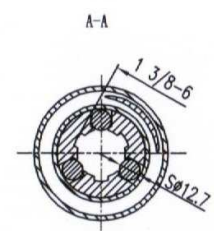
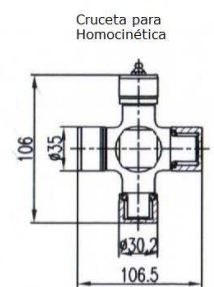
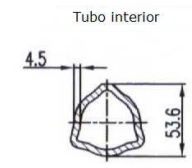
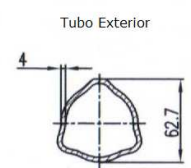
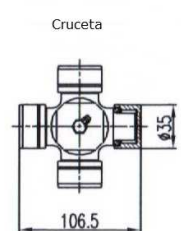
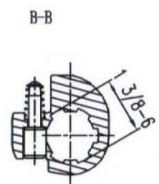
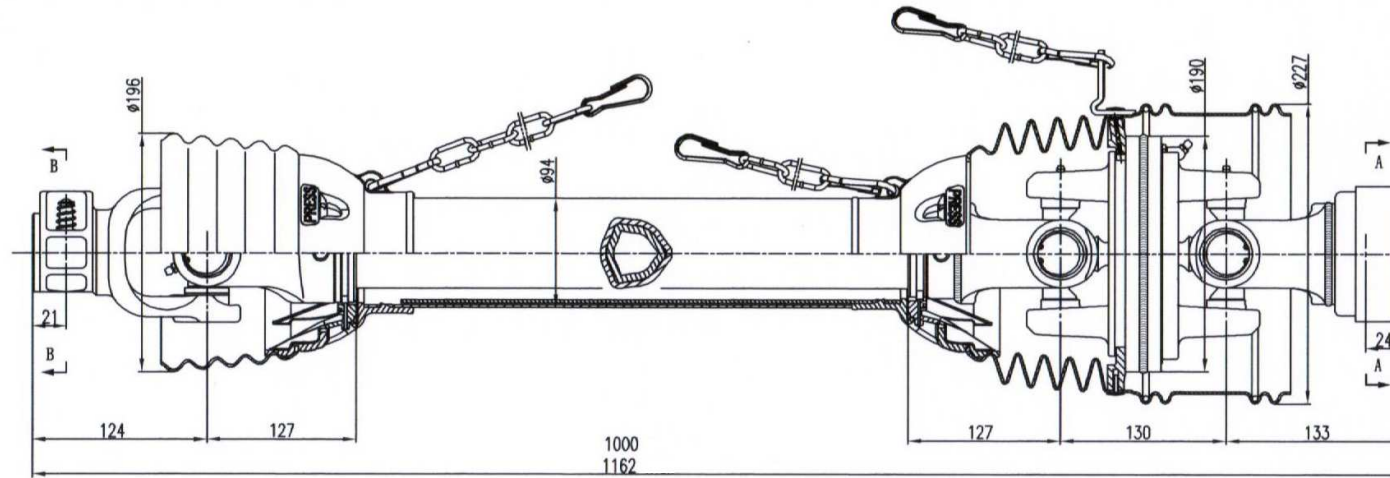

**manuman**

MANUTENCION Y MANTENIMIENTO INDUSTRIAL, S.L.

Pol. Ind. CONGOST. C/ Can Albareda, 46  
08760 MARTORELL (Barcelona)  
Tel. 937 765 573 - Fax 937 765 701  
E-mail: manuman@manumansi.es  
www.manumansi.es

Parametros nominales					
540 r.p.m			1000 r.p.m		
Cv	Kw	Nm	Cv	Kw	Nm
95	70	1240	150	110	1050

**Ref. P08T11/1200H**