

**TRANSMISIÓN TRIANGULAR DE L=1200mm, CRUCETA 30,2-92mm, TERMINALES 13/8"Z6
HOMOCINÉTICA**

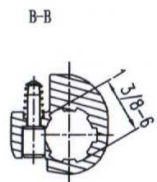
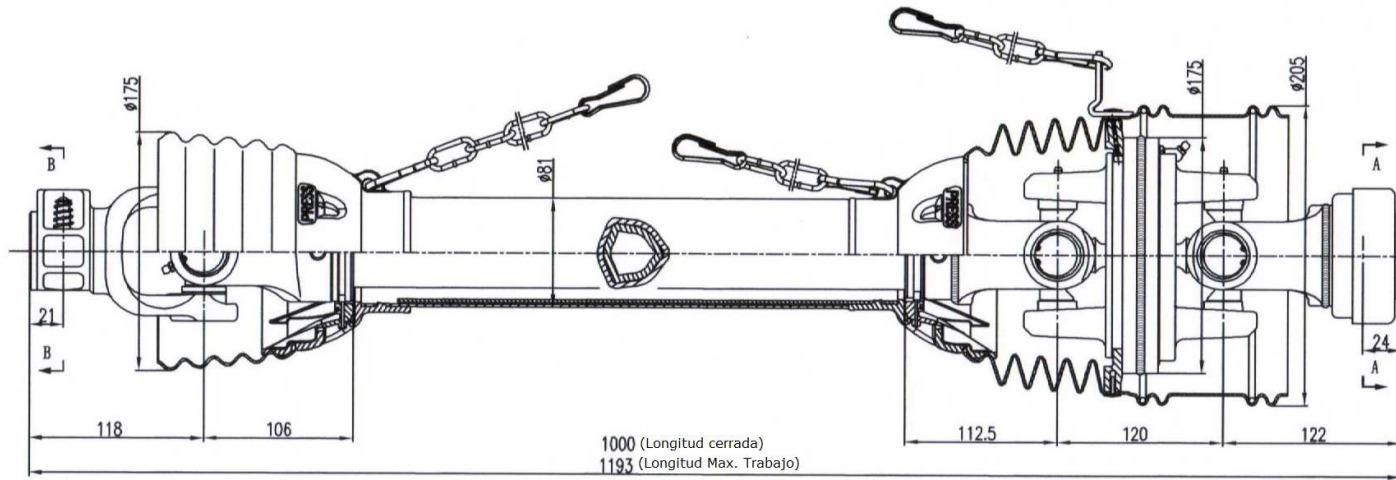

manuman

MANUTENCION Y MANTENIMIENTO INDUSTRIAL, S.L.

Pol. Ind. CONGOST. C/ Can Albareda, 46
08760 MARTORELL (Barcelona)
Tel. 937 765 573 - Fax 937 765 701
E-mail: manuman@manumansi.es
www.manumansi.es

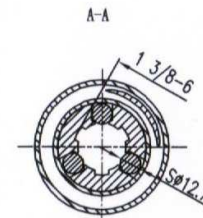
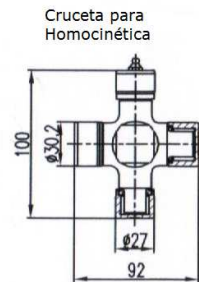
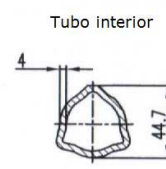
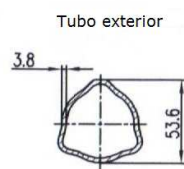
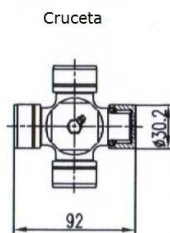

Parámetros nominales					
540 r.p.m			1000 r.p.m		
Cv	Kw	Nm	Cv	Kw	Nm
64	47	830	100	74	710

**Ref.
P06T11/1200H**